

# VS-R265 / VS-R264

## Guide to point-to-point streaming (unicast) between different networks

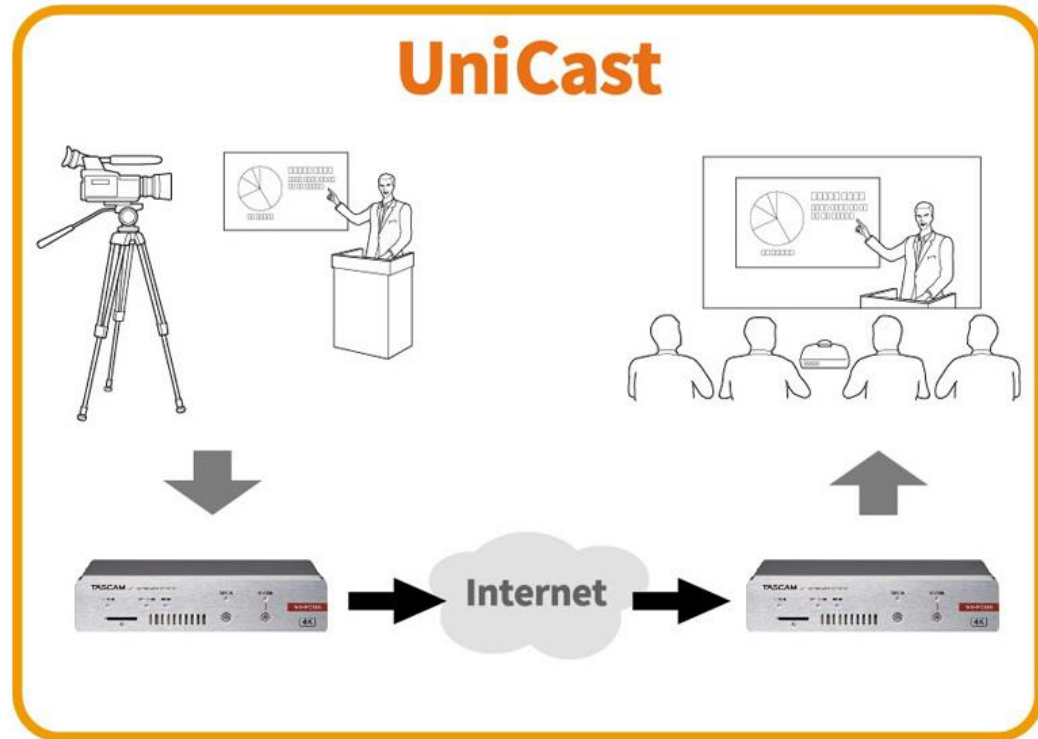

### <Precautions>

It is necessary to secure a stable bandwidth to establish a stable streaming between bases in different networks. Please consult with a network contractor in case construction is needed.

TEAC Corporation

Issued October 2020 (revised December 2021)

# < Table of contents >

- Required equipment . . . . . page 3
- Connection . . . . . page 4~5
  
- 1. Encoder side setup
  - (1) PC setup . . . . . page 6
  - (2) VS-R265 setup . . . . . page 7~11
  - Confirming the settings . . . . . page 12
- 2. Decoder side setup
  - (1) PC setup . . . . . page 13
  - (2) VS-R265 setup . . . . . page 14~18
  - (3) Router setup . . . . . page 19
  - Confirming all settings . . . . . page 20
  
- Troubleshooting . . . . . page 21

## • Required equipment

### 【Encoder side】

VS-R265 (or VS-R264 )	1 set	
PC (for setup)	1 set	
Router	1 set	
Camera(s) or other visual equipment		1 set

### 【Decoder side】

VS-R265 (or VS-R264 )	1 set
PC (for setup)	1 set
Router	1 set
Video monitor	1 set

Note: AC adapters and other accessories are omitted from this list.

- **Connection: Connect as shown in the picture below.**

Encoder side

Decoder side

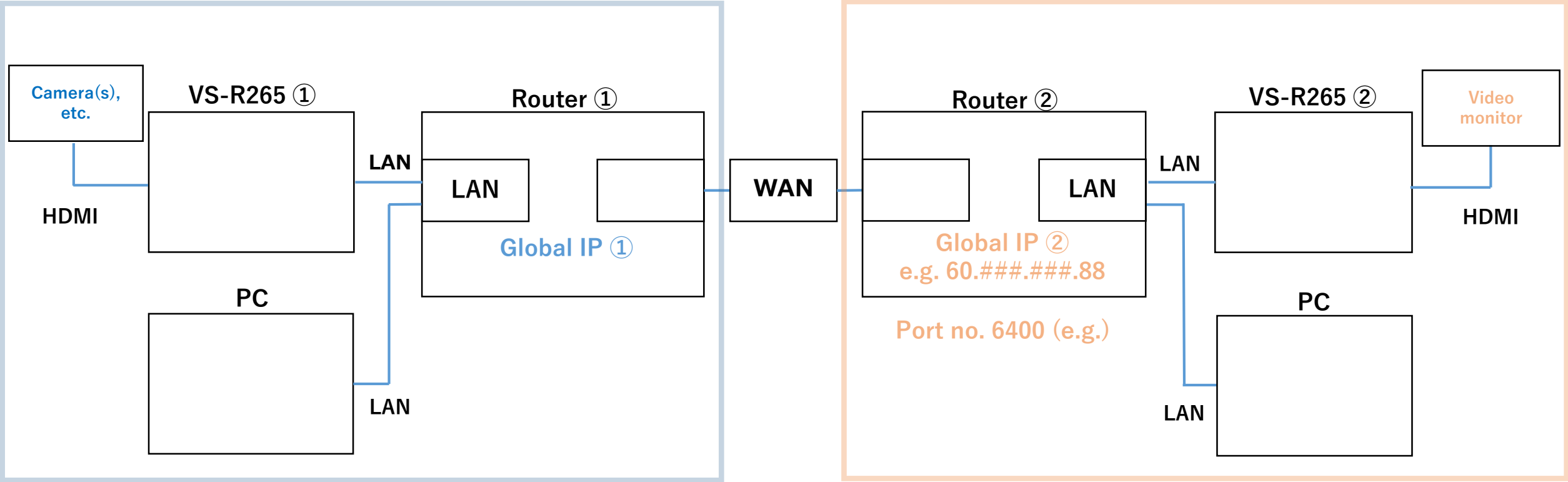

# • Connection

## ① Obtaining the global IP address (public IP address) of the decoder's network

Connect the computer and the decoder on the same network and search “what is my IP” on Google (\*1). Write down the network's global IP address.

e.g. 60.###.###.88 (\*2)

\* 1 : The global IP address may differ depending on whether the decoder is connected or not. Also, the global IP address will be reassigned and may change if the router settings are changed and then rebooted.

\* 2 : “###” represent whole numbers between 1~255

## ② Setting the port number transferred by the decoder's network

The user can freely set the port number using even numbers between 1024 - 49150. Write down the port number once decided.

In this guide, the port number will be 6400.

# 1. Encoder side setup

## (1) PC setup

Since the VS-R265's factory default private IP address is 192.168.1.100, this guide will use this initial value to set the computer's private address.

IP address	: 192.168.1.19 (*1)
Sub-net mask	: 255.255.255.0
Default gateway	: 192.168.1.1 (*2: router's IP address)

\*1: The IP addresses above are just examples. They can be set arbitrarily as long as they have the same network address.

Both PC and VS-R265 can be set to "Automatic (DHCP)".

\*2: In case of Windows, the IP address settings can be changed from  
Control Panel > All Control Panel Items > Network Connections

# 1. Encoder side setup

## (2) VS-R265 setup #1

① Use the TASCAM DISCOVERY application to recognize the VS-R265 on the computer.

② Press the Open button on the right to open the Streaming Dashboard on a browser.

Note: TASCAM DISCOVERY can be downloaded from the TASCAM website.

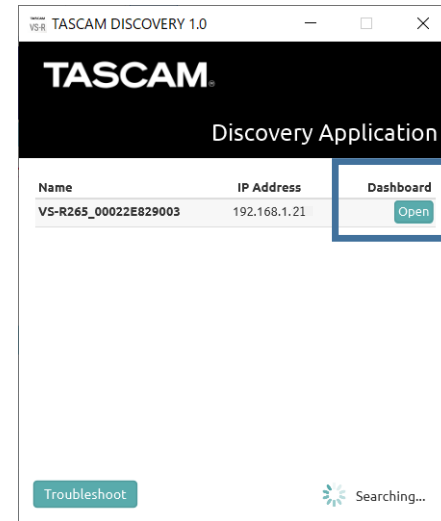

Press this button to open the Streaming Dashboard

[TASCAM DISCOVERY start screen]

# 1. Encoder side setup

## (2) VS-R265 setup #2

③ Select “Device Settings” on the top right of the Streaming Dashboard screen.

④ Select the Network tab on the left, change “Address Assignment” to “Manual (Static)”, and set the private IP address.

In this case 192.168.1.21 (e.g.)

Note: the private IP address will be automatically set if “Address Assignment” is set to “Automatic (DHCP)”.

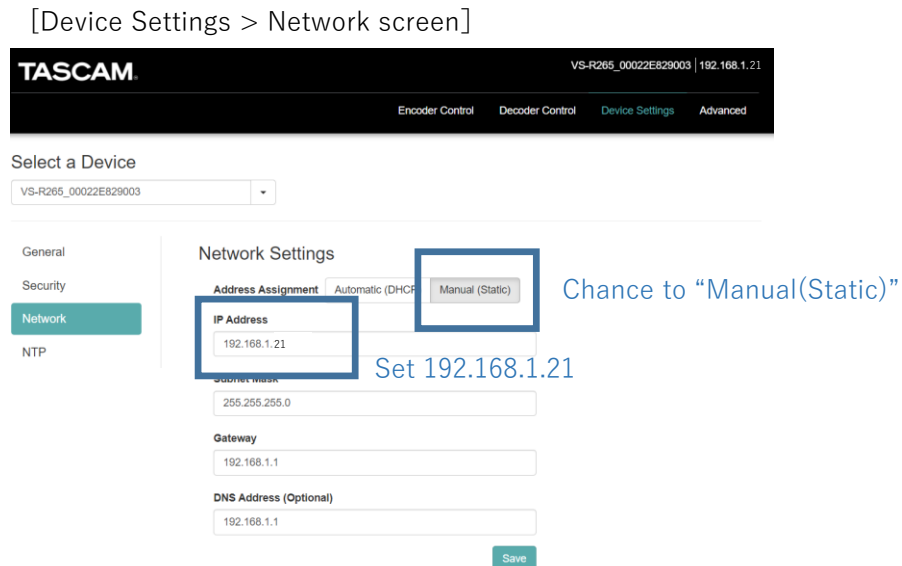
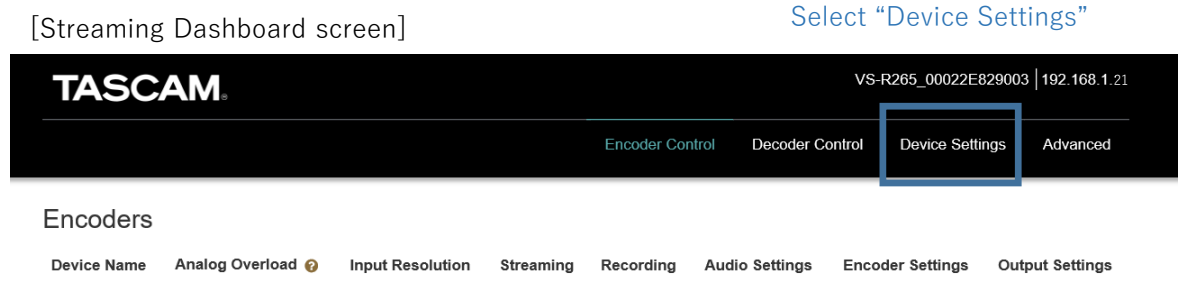



# 1. Encoder side setup

## (2) VS-R265 setup #3

⑤ Select the General tab on the left, set the Encoder to ON, and save settings.

[Device Settings > General screen]

The screenshot shows the TASCAM web interface for device settings. At the top, there is a black header with the TASCAM logo on the left and the device ID 'VS-R265\_00022E829003' and IP address '192.168.1.21' on the right. Below the header is a navigation bar with four tabs: 'Encoder Control', 'Decoder Control', 'Device Settings', and 'Advanced'. The 'Device Settings' tab is selected. Underneath, there is a 'Select a Device' dropdown menu showing 'VS-R265\_00022E829003'. On the left side, there is a vertical menu with four options: 'General', 'Security', 'Network', and 'NTP'. The 'General' option is highlighted with a teal background. The main content area is titled 'General Settings' and contains a 'Name' field with the value 'VS-R265\_00022E829003'. Below this is a 'Device Roles' section with two toggle switches: 'Encoder' (set to 'On') and 'Decoder' (set to 'Off'). A blue box highlights the 'Encoder' toggle, and a blue text annotation next to it says 'Set the Encoder to ON and save'. Another blue box highlights the 'Save' button at the bottom right of the settings area.

# 1. Encoder side setup

## (2) VS-R265 setup #4

⑥ Select Encoder Control on the top center. Turning ON the Encoder will display the VS-R265 on the screen.

⑦ Press the Configure button below “Output Settings” and open the Output Settings screen.

[Encoder Control screen]

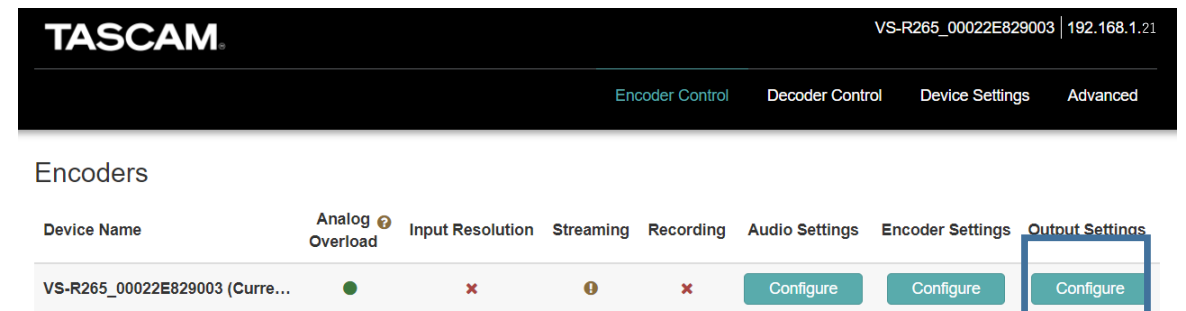

Press the Configure button

[Output Settings画面]

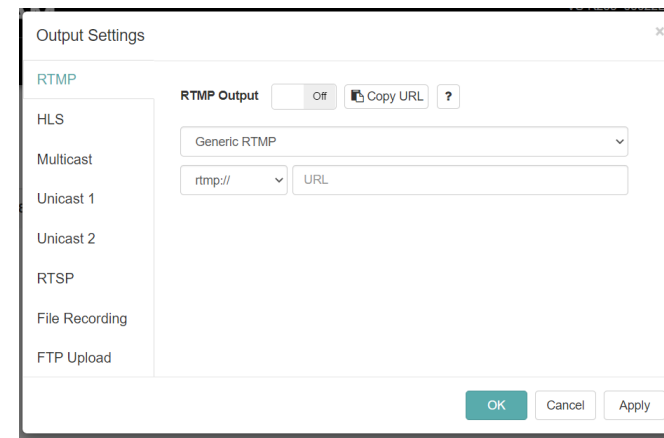

# 1. Encoder side setup

## (2) VS-R265 setup #5

⑧ The settings are as shown on the screen.

- Unicast Output1 : On
- Protocol : Select “rtp://” to increase reliability or “udp://” to decrease waiting time.
- IP address : Global IP address of the decoder side. In this case, 60.###.###.88
- Port : in this case 6400

[Output Settings Unicast1 screen]

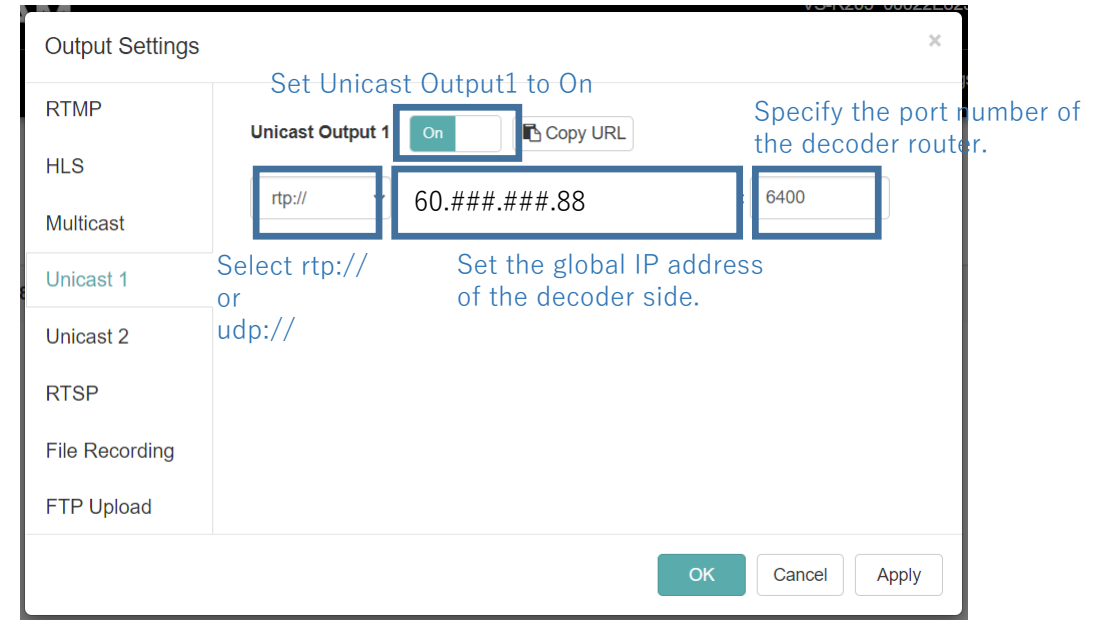

# 1. Confirming the settings

Encoder side

Decoder side

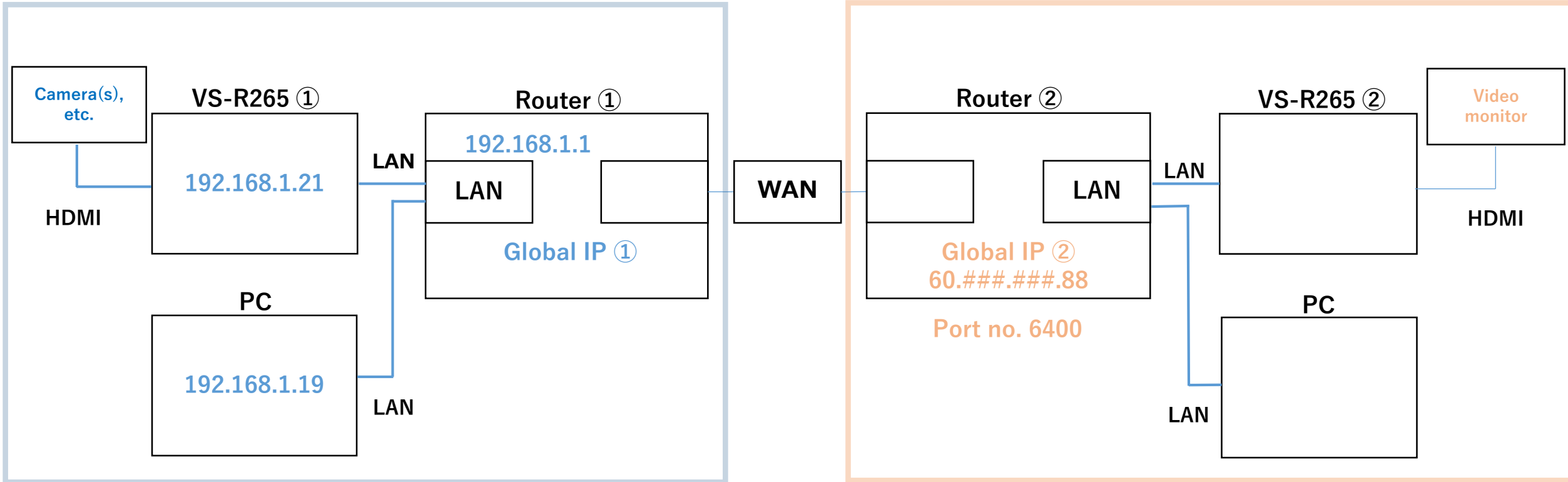

## 2. Decoder side setup

### (1) PC setup

Since the VS-R265's factory default private IP address is 192.168.1.100, this guide will use this initial value to set the computer's private address.

IP address	: 192.168.1.19 (*1)
Sub-net mask	: 255.255.255.0
Default gateway	: 192.168.1.1 (*2: router's IP address)

\*1: The IP addresses above are just examples. They can be set arbitrarily as long as they have the same network address.

\*2: In case of Windows, the IP address settings can be changed from  
Control Panel > All Control Panel Items > Network Connections

# 1. Decoder side setup

## (2) VS-R265 setup #1

① Use the TASCAM DISCOVERY application to recognize the VS-R265 on the computer.

② Press the Open button on the right to open the Streaming Dashboard on a browser.

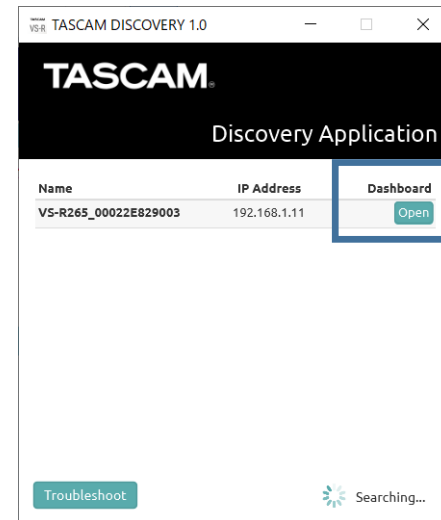

Press this button to open the Streaming Dashboard

[TASCAM DISCOVERY start screen]

# 1. Decoder side setup

## (2) VS-R265 setup #2

③ Select “Device Settings” on the top right of the Streaming Dashboard screen.

④ Select the Network tab on the left, change “Address Assignment” to “Manual (Static)”, and set the private IP address.

In this case 192.168.1.11 (e.g.)

[Streaming Dashboard screen]

Select “Device Settings”

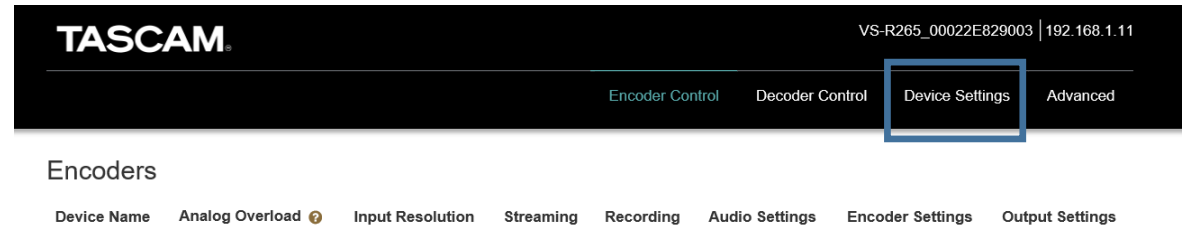

[Device Settings > Network screen]

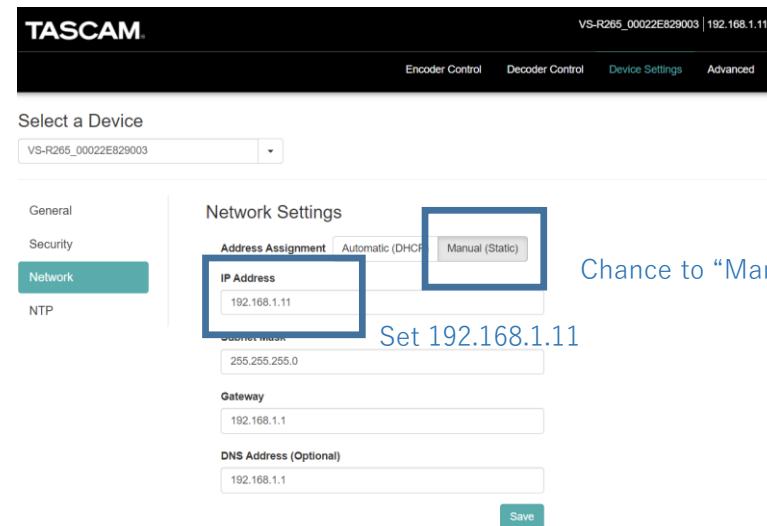

# 1. Decoder side setup

## (2) VS-R265 setup #3

⑤ Select the General tab on the left, set the Decoder to ON, and save settings.

[Device Settings > General screen]

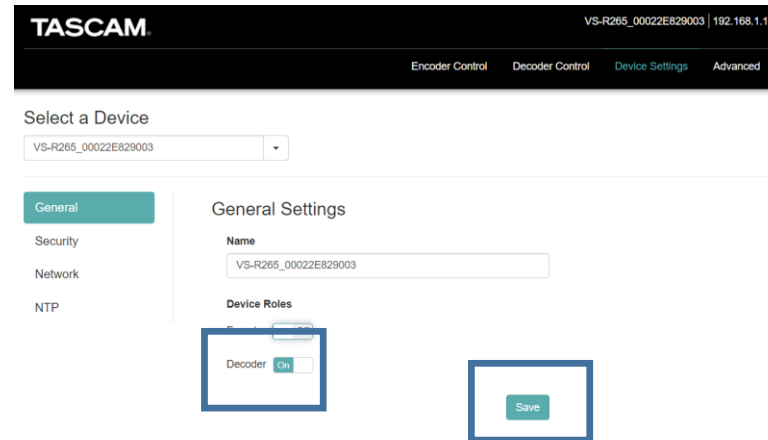

The screenshot shows the TASCAM web interface for the VS-R265 device. The top navigation bar includes 'Encoder Control', 'Decoder Control', 'Device Settings', and 'Advanced'. The 'Device Settings' tab is active. Below the navigation bar, there is a 'Select a Device' dropdown menu with 'VS-R265\_00022E829003' selected. On the left side, there is a sidebar with tabs for 'General', 'Security', 'Network', and 'NTP'. The 'General' tab is selected. The main content area is titled 'General Settings' and contains a 'Name' field with the value 'VS-R265\_00022E829003'. Under the 'Device Roles' section, there is a 'Decoder' toggle switch that is currently set to 'On'. A 'Save' button is located at the bottom right of the settings area. Both the 'Decoder On' toggle and the 'Save' button are highlighted with blue rectangular boxes.

Set the Decoder to ON and save



# 1. Decoder side setup

## (2) VS-R265 setup #4

⑥ Select Decoder Control on the top right. Turning ON the Decoder will display the VS-R265 on the screen.

⑦ Press the Configure button below “Stream Settings” and open the Decoder Stream Settings screen.

[Decoder Control screen]

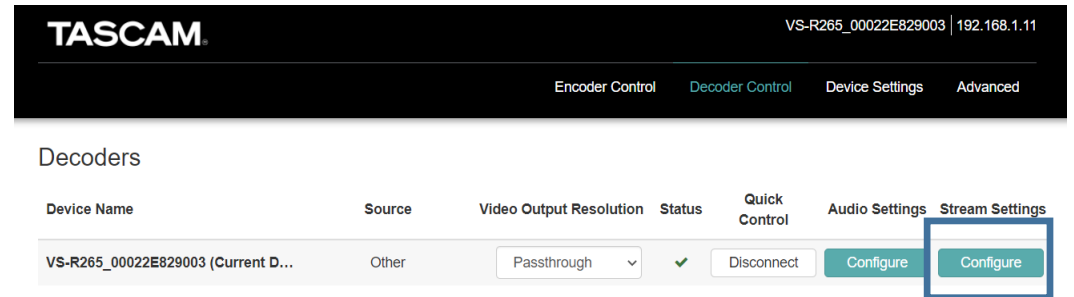

[Decoder Stream Settings screen]

Decoder Stream Settings

Source Encoder: Other Encoder

Stream Type: Unicast

Protocol: rtp://

Port: 6400

OK Cancel Apply

Press the Configure button

# 1. Decoder side setup

## (2) VS-R265 setup #5

⑧ The settings are as shown on the screen.

Source Encoder : Other Encoder

Stream Type : Unicast

Protocol : rtp:// or udp://  
(match with the encoder)

Port : in this case 6400

[Decoder Stream Settings screen]

Decoder Stream Settings

Source Encoder  
Other Encoder

Stream Type  
Unicast

Protocol  
rtp://

Port  
6400

OK Cancel Apply

## 2. Decoder side setup

### (3) Router setup

Set the router forwarding (opening) port to receive data from external networks.

In case the unit's DHCP server function is enabled, set the VS-R265 IP address to be fixed in order to use this function.

If the IP address is changed dynamically by the DHCP server function, the PC may be unintentionally opened to the WAN side, so be careful when changing settings.

Note: the settings are different on every router.

静的IPマスカレード設定

トップページ > 詳細設定 > 静的IPマスカレード設定 ヘルプ

高度な設定画面の[WAN→LAN中継設定]と静的IPマスカレード設定画面の内容が競合した場合は、高度な設定画面の[WAN→LAN中継設定]の内容が優先されます。設定変更を行うと、通信・通話が切断されることがあります。

対象インタフェースを選択

【静的IPマスカレード設定】

有効/無効	エントリ番号	変換対象プロトコル	変換対象ポート	宛先IPアドレス	宛先ポート	操作
<input checked="" type="checkbox"/>	1	UDP	6400	192.168.1.11	6400	<input type="button" value="編集"/> <input type="button" value="削除"/>
<input type="checkbox"/>	2					<input type="button" value="編集"/> <input type="button" value="削除"/>
<input type="checkbox"/>	3					<input type="button" value="編集"/> <input type="button" value="削除"/>
<input type="checkbox"/>	4					<input type="button" value="編集"/> <input type="button" value="削除"/>
<input type="checkbox"/>	5					<input type="button" value="編集"/> <input type="button" value="削除"/>
<input type="checkbox"/>	6					<input type="button" value="編集"/> <input type="button" value="削除"/>
<input type="checkbox"/>	7					<input type="button" value="編集"/> <input type="button" value="削除"/>
<input type="checkbox"/>	8					<input type="button" value="編集"/> <input type="button" value="削除"/>

[Port forwarding setting screen (example) ]

# 2. Confirming all settings

Encoder side

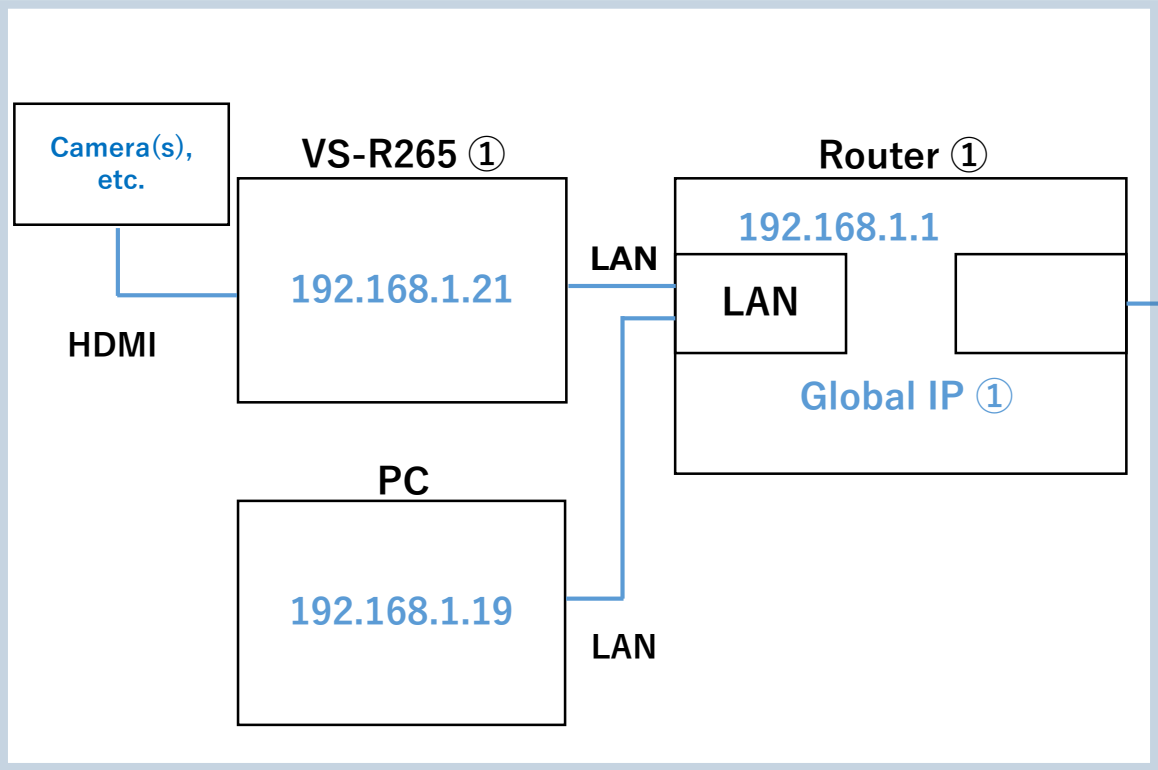

Decoder side

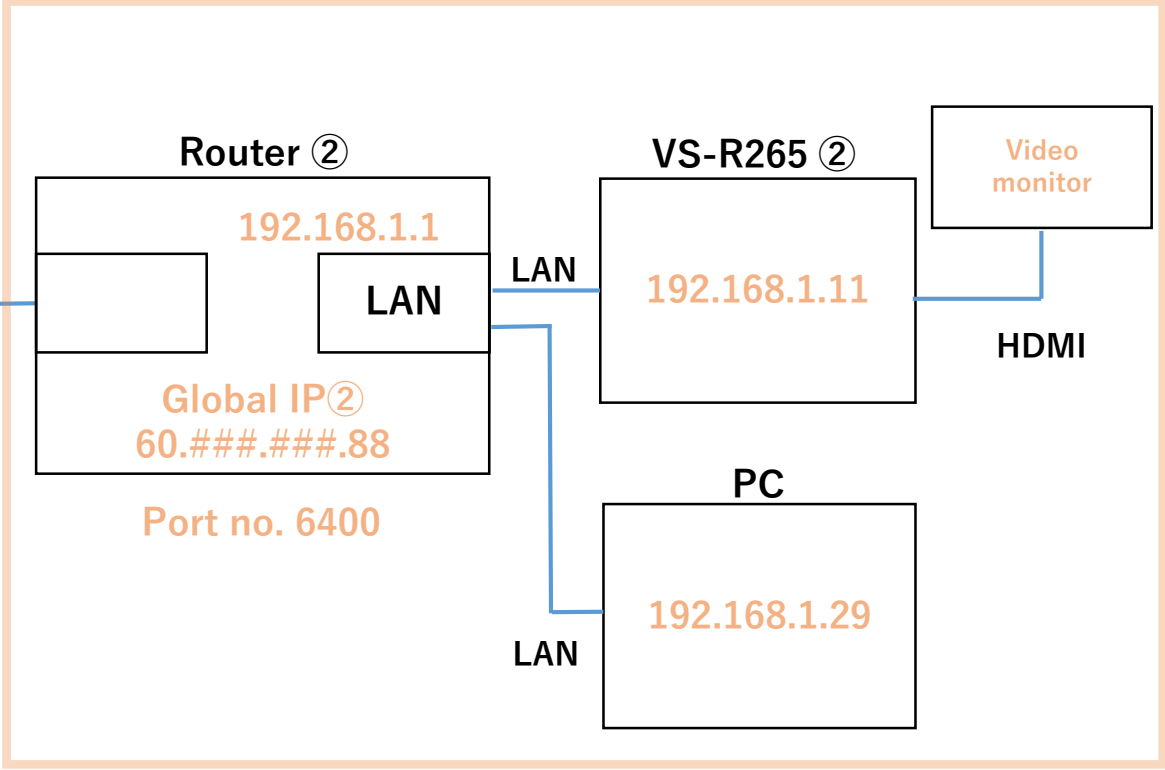

# Troubleshooting

- **The computer cannot recognize the VS-R265.**

- ⇒ Make sure the VS-R265's private IP address matches that of the computer's.

- ⇒ The private IP address may change dynamically if the VS-R265's private IP address is set to DHCP.

- Use a USB memory flash, etc. or the TASCAM DISCOVERY application to check the private IP address.

- **Cannot receive data from external networks.**

- ⇒ Check if the port forwarding settings of the router are set correctly.

- ⇒ The global IP address may change if the router settings or the equipment connected to the router is changed. Check the current global IP address and set the encoding output settings.

- ⇒ This may improve by disconnecting and reconnecting the decoder side's VS-R265 via Streaming Dashboard.

- **The decoded video is distorted.**

- ⇒ Changing the VS-R265 settings on the encoder side may improve this.

- Go to Encoder Settings > Video Encoding and reduce the data transfer amount (kbps).

- ⇒ The transfer quality may deteriorate depending on the specifications of the network line, the distance between bases, and the load on the network line. Please consult your network operator regarding these measures.